

# Technical data sheet

## Support clamp, with pipe seat at bottom

Item number: 1488393



Support clamp for mounting pipes. Open pipe seat at bottom. Fastening through knocking onto steel girders.

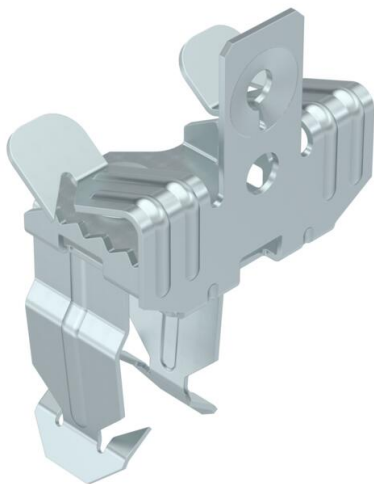

CE

- St Steel
- ZL Zinc slat

### Master data

Item number	1488393
Type	SCVPO 7-13 D25
Description 1	Beam clamp
Description 2	with bottom pipe clamp 25 mm
Manufacturer	OBO
Dimension	7-13mm
Material	Steel
Surface	Zinc slat
Surface standard	
Smallest sales unit	50
Unit of quantity	Piece
Weight	4.1 kg
Weight unit	kg/100 pc.

# Technical data sheet

## Support clamp, with pipe seat at bottom

Item number: 1488393



### Dimensions

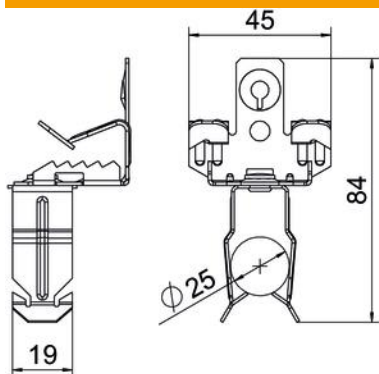

Length	84 mm
Width	45 mm
Height	39 mm
Dimension L	84 mm
Maß W	45 mm

### Technical data

Connection type/component	Pipe/cable
Fastening type	Clamp
Flange thickness F max.	13 mm
Flange thickness F min.	7 mm
Pipe/cable diameter, max.	30 mm
Pipe/cable diameter, min.	22 mm
Hinge, adjustable	no
Hinged	no