

Technical data sheet

Hot-dip galvanised steel bend, with thread

Item number: 2046788



90° bend for electrical installation pipes according to EN 61386-1 with threaded ends to DIN EN 60423. With burr-free inner wall.
One connection sleeve is already screwed onto each pipe bend.



St Steel

FT Hot-dip galvanised

Master data

Item number	2046788
Type	SBNM25 FT
Description 1	Conduit threaded bend
Description 2	with threaded coupler
Manufacturer	OBO
Dimension	M25x1,5
Material	Steel
Surface	Hot-dip galvanised
Surface standard	DIN EN ISO 1461
Smallest sales unit	25
Unit of quantity	Piece
Weight	33 kg
Weight unit	kg/100 pc.

Technical data sheet

Hot-dip galvanised steel bend, with thread

Item number: 2046788



Dimensions

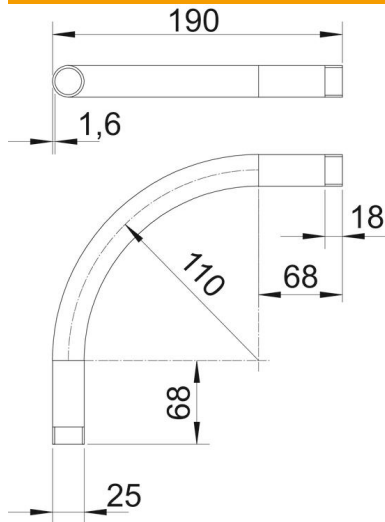

Dimension A	68 mm
Dimension B	190 mm
Dimension D	25 mm
Dimension l	18 mm
Dimension m (mm)	M25
Dimension R	110 mm
Dimension t	1.6 mm

Technical data

Version for	Thread
Flexible	no
For nominal pipe diameter	25 mm
Thread	M25x1,5
Halogen-free	no
With inspection opening and lid	no
With sleeve	yes
Brushed surface	no
Polished surface	no
Angle of the bend	90 °
Two-part	no