

Technical data sheet

Stainless steel pipe bend, V4A

Item number: 2046765



90° bend with moulded sleeves, for electrical installation pipes according to EN 61386-1. With burr-free inner wall.



A4 Stainless steel

2B Bright, treated

Master data

Item number	2046765
Type	SB50W A4
Description 1	Stainless steel bend
Description 2	without thread
Manufacturer	OBO
Dimension	Ø50mm
Material	Stainless steel
Surface	Bright, treated
Surface standard	
Smallest sales unit	5
Unit of quantity	Piece
Weight	79.5 kg
Weight unit	kg/100 pc.

Technical data sheet

Stainless steel pipe bend, V4A



Item number: 2046765

Dimensions

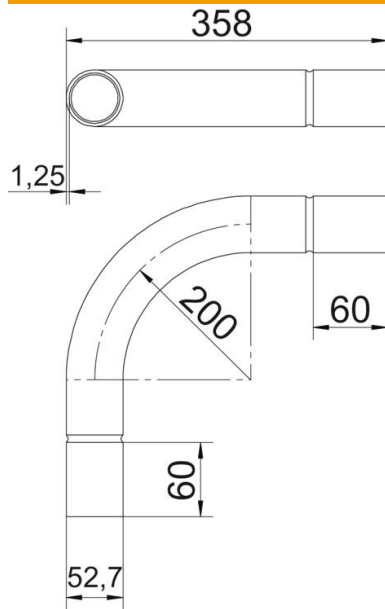

Dimension A	60 mm
Dimension B	358 mm
Dimension D	52.7 mm
Dimension d	50.2 mm
Dimension l	50 mm
Dimension m (mm)	M50
Dimension R	200 mm
Dimension t	1.25 mm

Technical data

Version for	Connector
Flexible	no
For nominal pipe diameter	50 mm
Halogen-free	no
With inspection opening and lid	no
With sleeve	yes
Brushed surface	yes
Polished surface	no
Permitted temperature range, max.	400 °C
Permitted temperature range, min.	-45 °C
Angle of the bend	90 °
Two-part	no