

Technical data sheet

90° bend 60 FS

Item number: 6211428



Horizontal 90° bend, fitting for cable ladders, side height 60 mm With connector perforation. Can be used in indoor areas. Connector and fastening material must be ordered separately. Fittings must be supported by the support structure.



St Steel

FS Strip galvanized

Master data

Item number	6211428
Type	LB 90 650 R5 FS
Description 1	90° bend
Description 2	for cable ladder, horizontal
Manufacturer	OBO
Dimension	60x500
Material	Steel
Surface	Strip galvanized
Surface standard	DIN EN 10346
Smallest sales unit	1
Unit of quantity	Piece
Weight	562 kg
Weight unit	kg/100 pc.

Technical data sheet

90° bend 60 FS

Item number: 6211428



Dimensions

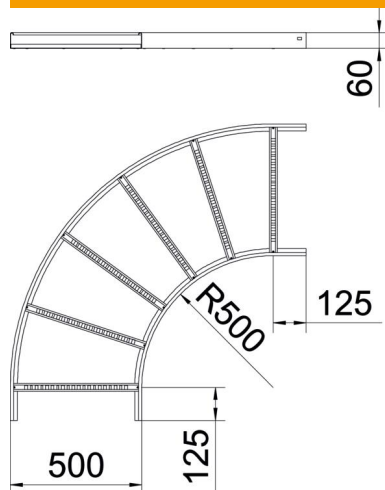

Width	500 mm
Height	60 mm
Dimension B	500 mm
Dimension R	500 mm

Technical data

Bend (angle)	90°
Version of the rungs	Profile unperforated
Side rail version	Flat profile
Maintain electrical functions	no
Change of direction	Horizontal
Rustproof steel, pickled	no
Hinged	no
Side perforation	no
Wide-span version	no
Rail thickness	1.5 mm