

Technical data sheet

90° bend 60 FT

Item number: 6211454



Horizontal 90° bend, fitting for cable ladders, side height 60 mm With connector perforation. Can be used indoors and outdoors. Connector and fastening material must be ordered separately. Fittings must be supported by the support structure.



St Steel

FT Hot-dip galvanised

Master data

Item number	6211454
Type	LB 90 640 R5 FT
Description 1	90° bend
Description 2	for cable ladder, horizontal
Manufacturer	OBO
Dimension	60x400
Material	Steel
Surface	Hot-dip galvanised
Surface standard	DIN EN ISO 1461
Smallest sales unit	1
Unit of quantity	Piece
Weight	500 kg
Weight unit	kg/100 pc.

Technical data sheet

90° bend 60 FT

Item number: 6211454



Dimensions

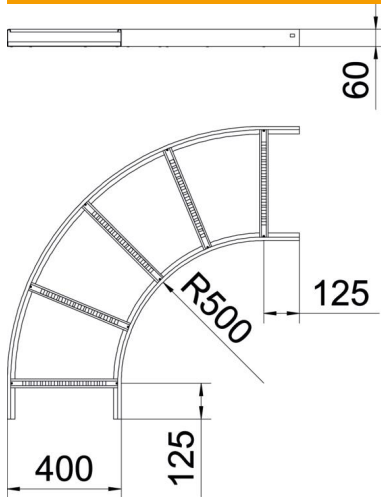

Width	400 mm
Height	60 mm
Dimension B	400 mm
Dimension R	400 mm

Technical data

Bend (angle)	90°
Version of the rungs	Profile unperforated
Side rail version	Flat profile
Maintain electrical functions	no
Change of direction	Horizontal
Rustproof steel, pickled	no
Hinged	no
Side perforation	no
Wide-span version	no
Rail thickness	1.5 mm