

Technical data sheet

90° bend 60 FT

Item number: 6211452



Horizontal 90° bend, fitting for cable ladders, side height 60 mm With connector perforation. Can be used indoors and outdoors. Connector and fastening material must be ordered separately. Fittings must be supported by the support structure.



St Steel

FT Hot-dip galvanised

Master data

Item number	6211452
Type	LB 90 630 R5 FT
Description 1	90° bend
Description 2	for cable ladder, horizontal
Manufacturer	OBO
Dimension	60x300
Material	Steel
Surface	Hot-dip galvanised
Surface standard	DIN EN ISO 1461
Smallest sales unit	1
Unit of quantity	Piece
Weight	487 kg
Weight unit	kg/100 pc.

Technical data sheet

90° bend 60 FT

Item number: 6211452



Dimensions

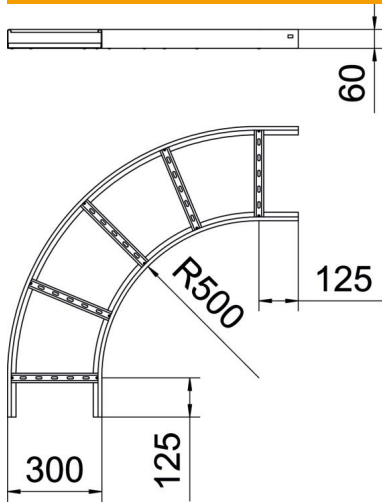

Width	300 mm
Height	60 mm
Dimension B	300 mm
Dimension R	300 mm

Technical data

Bend (angle)	90°
Version of the rungs	Profile unperforated
Side rail version	Flat profile
Maintain electrical functions	no
Change of direction	Horizontal
Rustproof steel, pickled	no
Hinged	no
Side perforation	no
Wide-span version	no
Rail thickness	1.5 mm