

# Technical data sheet

90° bend 110 FT

Item number: 6217772



90° bend, horizontal, for all wide span cable ladders of 110 mm side height. Connectors should be ordered separately and in the appropriate quantity.



**St** Steel

**FT** Hot-dip galvanised

## Master data

Item number	6217772
Type	LB 90 1120 R5 FT
Description 1	90° bend
Description 2	for cable ladder, horizontal
Manufacturer	OBO
Dimension	110x200
Material	Steel
Surface	Hot-dip galvanised
Surface standard	DIN EN ISO 1461
Smallest sales unit	1
Unit of quantity	Piece
Weight	536 kg
Weight unit	kg/100 pc.

# Technical data sheet

90° bend 110 FT

Item number: 6217772



## Dimensions

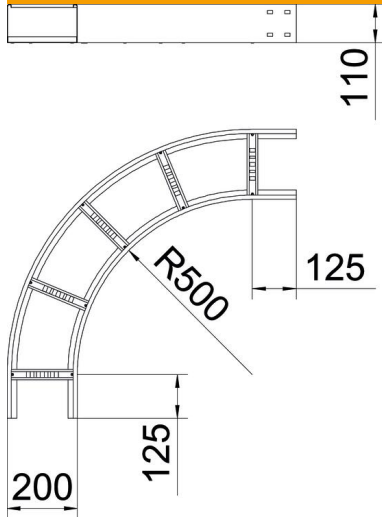

Width	200 mm
Height	110 mm
Dimension B	200 mm
Dimension R	200 mm

## Technical data

Bend (angle)	90°
Version of the rungs	Profile unperforated
Side rail version	Flat profile
Maintain electrical functions	no
Change of direction	Horizontal
Rustproof steel, pickled	no
Side perforation	no
Wide-span version	no