

# Technical data sheet

## Pipe bend, plastic, halogen-free

Item number: 2047740



Accessory part: 90° bend to EN 61386 (Code: 4421) for halogen-free electrical installation pipes.



Polycarbonate/Acrylnitrile-butadiene-styrene

### Master data

Item number	2047740
Type	KBH32 LGR
Description 1	Plastic armoured pipe bend
Description 2	halogen-free
Manufacturer	OBO
Dimension	Ø32mm
Colour	Light grey; RAL 7035
Material	Polycarbonate/Acrylnitrile-butadiene-styrene
Smallest sales unit	25
Unit of quantity	Piece
Weight	7.9 kg
Weight unit	kg/100 pc.

# Technical data sheet

Pipe bend, plastic, halogen-free

Item number: 2047740



## Dimensions

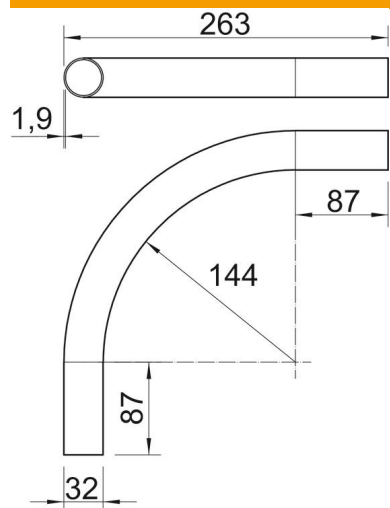

Length	263 mm
Dimension A	87 mm
Dimension D	32 mm
Dimension L	263 mm
Dimension m (mm)	M32
Dimension R	144 mm
Dimension t	1.9 mm

## Technical data

Version for	Connector
Flexible	no
For nominal pipe diameter	32 mm
Halogen-free	yes
With sleeve	no
Angle of the bend	90 °