

Technical data sheet

Earthing pipe clamp for EX Zone 1/21, 2/22

Item number: 5057640



For ignition spark-free protection/functional equipotential bonding according to DIN VDE 0100-410/-540 and ignition spark-free lightning protection equipotential bonding according to VDE 0185-305 (IEC 62305) in systems according to VDE 0165-1 (IEC/EN 60079-14).

- For pipes of 6–500 mm external diameter
- Use in potentially explosive areas, Ex zone 1 and 2/21 and 22
- Tested according to explosion group IIC
- Lightning current carrying capacity class H (100 kA) to VDE 0185-561-1 (IEC/EN 62561-1)
- UV-resistant and halogen-free plastic hood
- Secured with bolts against self-loosening to VDE 0185-305-3, Supplementary Sheet 2
- Suitable for indoor and outdoor applications



Master data

Item number	5057640
Type	EX BES 300
Description 1	Strip earthing clip
Description 2	for Ex areas
Manufacturer	OBO
Dimension	300mm
Smallest sales unit	1
Unit of quantity	Piece
Weight	35.8 kg
Weight unit	kg/100 pc.

Technical data sheet

Earthing pipe clamp for EX Zone 1/21, 2/22

Item number: 5057640



Dimensions

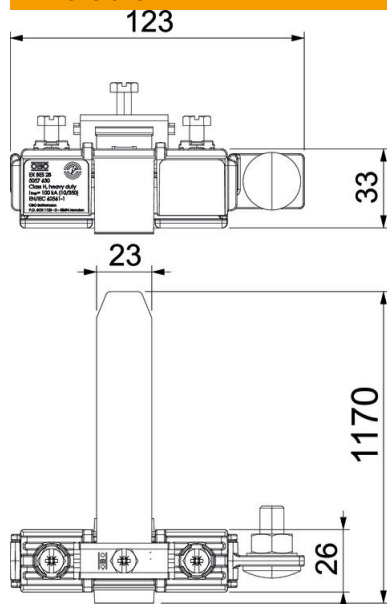

Dimension L 1,170 mm

Technical data

Number of conductors	2
Lightning current carrying capacity	H/100 kA
For pipe diameter, max.	300 mm
For pipe diameter, min.	28 mm
Cross-section of cable to be connected, max.	78 mm ²
Cross-section of cable to be connected, min.	16 mm ²