

Technical data sheet

Clamp clip 2056, F-foot, single, plastic pressure trough, A2

Item number: 1188276



Clamp clip with F-foot, plastic pressure trough made of polypropylene. For vertical and horizontal mounting of 1 single cable on flat bars. With 1-start screw thread on pressure trough, universal hexagonal screw head WAF10, with slot and cross recess. Suitable for mounting indoors and outdoors. We recommend the use of a counter-trough.



A2 Stainless steel

2B Bright, treated

Master data

Item number	1188276
Type	BS-F1-K-40 A2
Description 1	Clamp clip 2056
Manufacturer	OBO
Dimension	34-40mm
Material	Stainless steel
Surface	Bright, treated
Surface standard	
Smallest sales unit	100
Unit of quantity	Piece
Weight	7.022 kg
Weight unit	kg/100 pc.

Technical data sheet

Clamp clip 2056, F-foot, single, plastic pressure trough, A2



Item number: 1188276

Dimensions

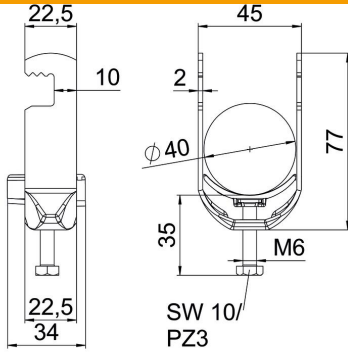

Length	22.5 mm
Width	45 mm
Height	77 mm
Plate thickness	2 mm
Dimension A	22.5 mm
Dimension B	45 mm
Dimension C	34 mm
Dimension G (mm)	M6
Dimension H	77 mm
Dimension L	35 mm
Dimension t	2 mm

Technical data

Number of cables/pipes	1
For pipe diameter, max.	40 mm
For pipe diameter, min.	34 mm
Thread	M6
Halogen-free	yes
Length of external dimensions	34 mm
Max. Tightening torque	3 Nm
With plastic trough	yes
Mounting type	Flat profile
Slot width	10 mm
Clamping range D, max.	40 mm
Clamping range D, min.	34 mm
Surface addition	Untreated
Material addition	Rustproof steel