

Technical data sheet

Spacer clip 732 A4

Item number: 1362486



Spacer clip for the installation of pipes and cables on walls, ceilings and floors. With self-locking cover. Fastening via attachment piece with internal thread.

Approved for the maintenance of electrical function according to DIN 4102 Part 12, maintenance of electrical function classes E 30 to E 90.



A4 Stainless steel

Master data

Item number	1362486
Type	ASG 732 53 A4
Description 1	Distance saddle
Description 2	with threaded connection M6
Manufacturer	OBO
Dimension	44-53mm
Material	Stainless steel
Smallest sales unit	20
Unit of quantity	Piece
Weight	4.851 kg
Weight unit	kg/100 pc.

Technical data sheet

Spacer clip 732 A4

Item number: 1362486



Dimensions

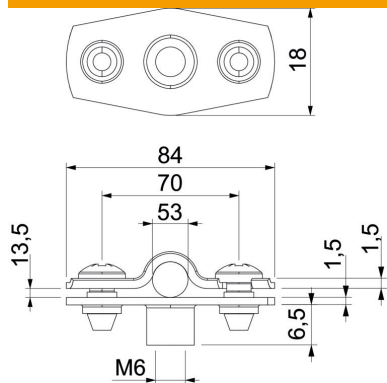

Dimension A	84 mm
Dimension B	70 mm
Dimension b	18 mm
Dimension D	53 mm
Dimension d max.	53 mm
Dimension d min.	44 mm
Dimension H1	12 mm
Dimension t1 (mm)	1.5
Dimension t2 (mm)	1.5
Dimension x	13.5 mm

Technical data

Distance to the wall	yes
Number of cables/pipes	1
Version for	Closed
Fastening type	Threaded connection
For diameter	44 - 53
Suitable in fire protection area	yes
Halogen-free	yes
Plastic-covered	no
Material thickness	1.5 mm
Clamping range D, max.	53 mm
Clamping range D, min.	44 mm
UV-resistant	yes