

# Technical data sheet

## Screw-in spacer clip

Item number: 1366351



With M6 thread.



**St** Steel

**G** Electrogalvanized

### Master data

Item number	1366351
Type	731 W 35 G
Description 1	Distance saddle
Description 2	with threaded connection M6
Manufacturer	OBO
Dimension	30-35mm
Material	Steel
Surface	Electrogalvanized
Surface standard	EN ISO 19598 / EN ISO 4042
Smallest sales unit	25
Unit of quantity	Piece
Weight	4.344 kg
Weight unit	kg/100 pc.

# Technical data sheet

## Screw-in spacer clip

Item number: 1366351



### Dimensions

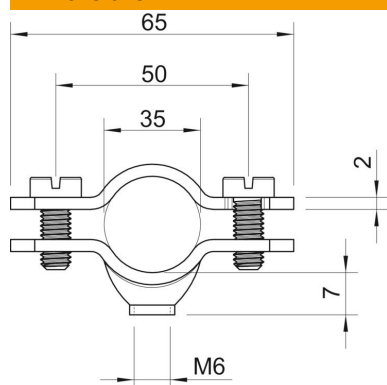

Length	65 mm
Dimension A	65 mm
Dimension B	50 mm
Dimension D	35 mm
Dimension d min.	35 mm
Dimension t	2 mm

### Technical data

Number of cables/pipes	1
Version for	Closed
Fastening type	Screw hole
Suitable in fire protection area	no
Halogen-free	no
Plastic-covered	no
Hole size	M6 mm
Material thickness	2 mm
Bolt	M5 x 18
Clamping range D, max.	35 mm
Clamping range D, min.	30 mm
UV-resistant	yes