

Technical data sheet

Connection thread sealing ring, metric

Item number: 2030020



Connection thread sealing ring, suitable for all plastic cable glands, with metric thread according to DIN EN 60423 or ISO 68. The internal diameters of the sealing rings are designed in such a way that they can be pre-mounted in a captive manner.



PE Polyethylene

Master data

Item number	2030020
Description 1	Connection thread sealing ring
Manufacturer	OBO
Dimension	M32
Material	Polyethylene
Smallest sales unit	100
Unit of quantity	Piece
Weight	0.105 kg
Weight unit	kg/100 pc.

Dimensions

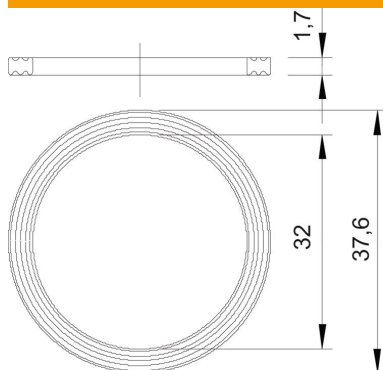

Dimension D1	37.6 mm
Dimension D2	32 mm
Dimension t	1.7 mm

Technical data

Version for	Flat sealing ring
Suitable for metric thread dimension	32
Inner diameter	32 mm